



C50

Quick Installation Guide

Guide d'installation rapide

安裝指示說明

安裝指示说明

Case	Quick Installation Guide	Accessory Pack
1X Step screw	4X 3.5" HDD screw	6X PSU screw
18X Motherboard standard screw	1X HDD anti-vibration pad	1X Hand screw
3X Copper pillar		
Boîtier	Guide d'installation rapide	Pack d'accessoires
1X Vis de marche	4X vis pour disque dur 3.5"	6X vis de bloc d'alimentation
18X vis de carte mère standard	1X Coussinet anti-vibration du disque dur	1X vis manuelle
3X Pilier de cuivre		
機殼	安裝指示說明	配件盒
1X 台階螺絲	4X 3.5" 硬碟螺絲	6X 電源螺絲
18X 主板螺絲	1X 硬碟防震墊	1X 手動螺絲
3X 主板腳柱		
机箱	安裝指示说明	零件盒
1X 台階螺丝	4X 3.5" 硬盘螺丝	6X 电源螺丝
18X 主板螺丝	1X 硬盘防震垫	1X 手动螺丝
3X 主板脚柱		

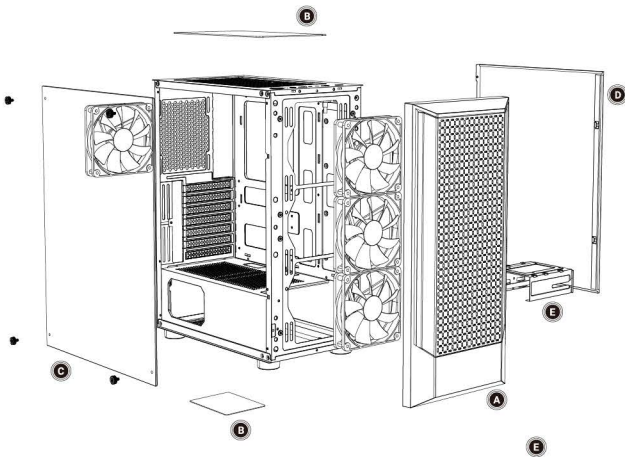

- | | | | |
|--|-----------------------------|-----------------|---------------|
| A Front Panel | D Side Panel | A 前面板 | D 右側板 |
| B Dust Filter | E Hard Drive Tray | B 濾網 | E 硬碟支架 |
| C Tempered Glass Side Panel | | C 強化玻璃側板 | |
| A Panneau avant | D Panneau latéral | A 前面板 | D 右側板 |
| B Filtre anti-poussière | E Rack de disque dur | B 過濾器 | E 硬碟支架 |
| C Panneau latéral en verre trempé | | C 鋼化玻璃側板 | |

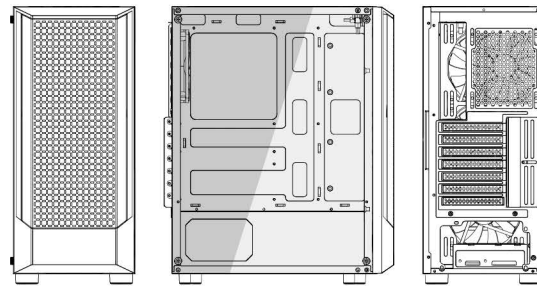

How to remove the Right side panel/Tempered glass side panel/front panel
 Comment retirer le panneau latéral droit / le panneau latéral en verre trempé / le panneau avant
 如何移除右側板 / 鋼化玻璃側板 / 前面板 / 如何移除右面板 / 鋼化玻璃面板 / 前面板

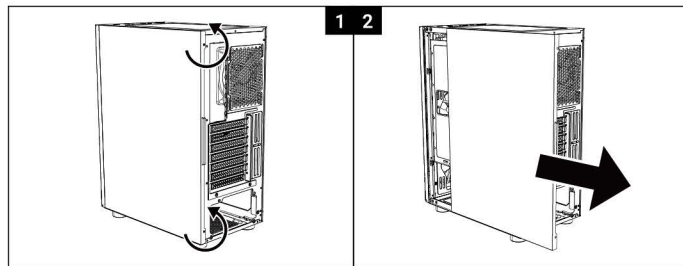
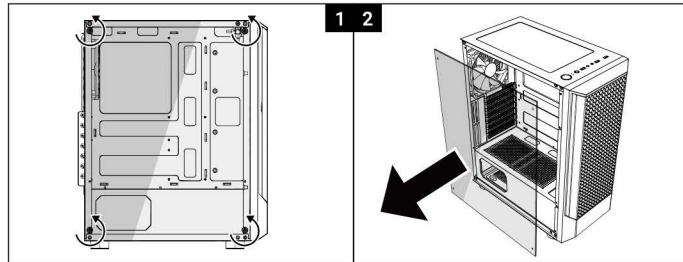

How to remove the dust filters/Comment retirer les filtres anti-poussière
 如何移除濾網 / 如何移除過濾器

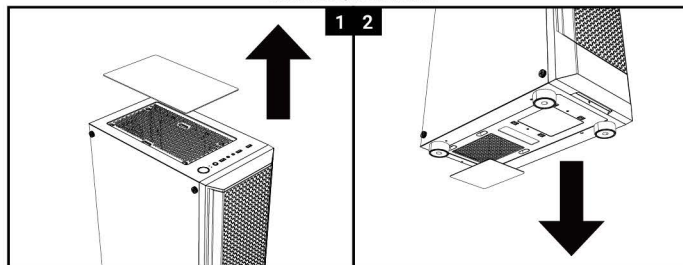

PSU Installation/Installation du bloc d'alimentation/電源安裝/電源安裝

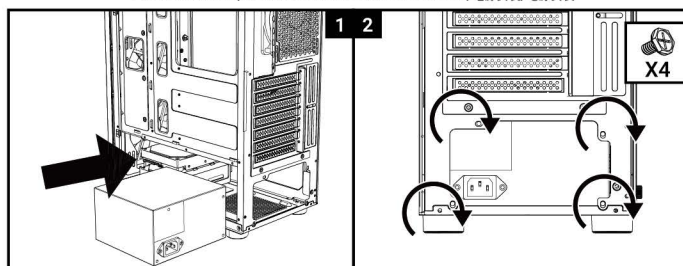

Drive Locations/Emplacements de disques durs/硬碟位置/硬盤位置

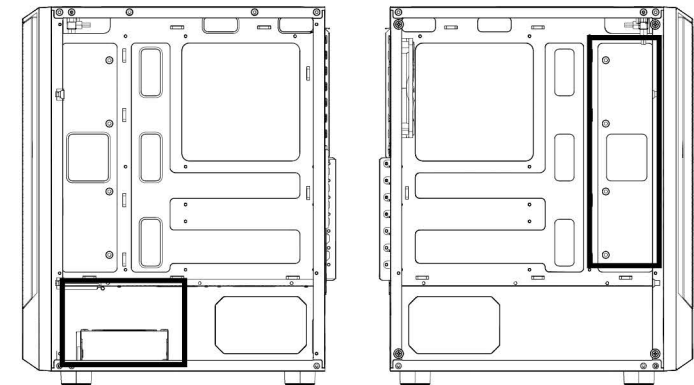

HDDx2 & SDDx2+1

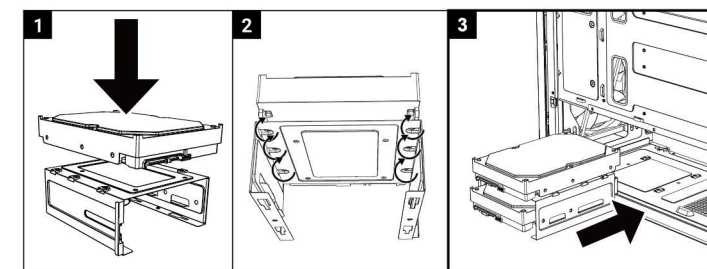
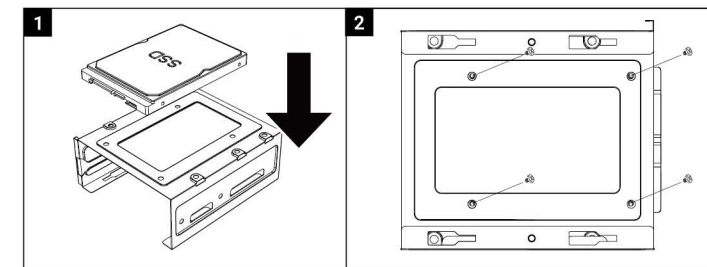
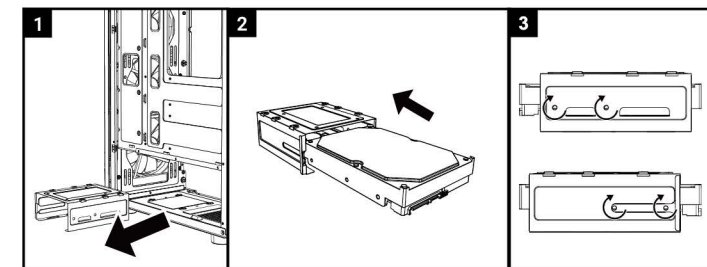
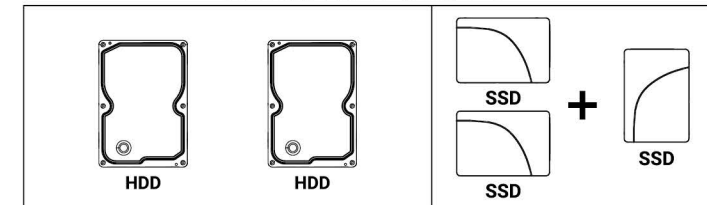

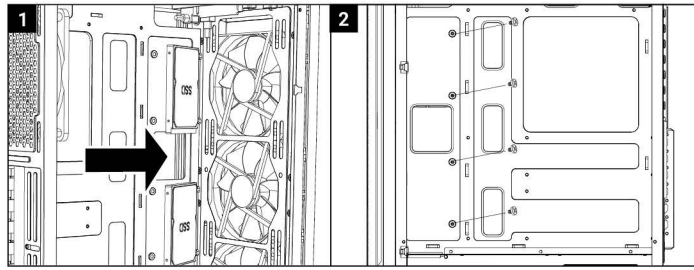

Fan (Back) Installation/Installation du ventilateur arrière
風扇(後方)安裝/風扇(後方)安裝

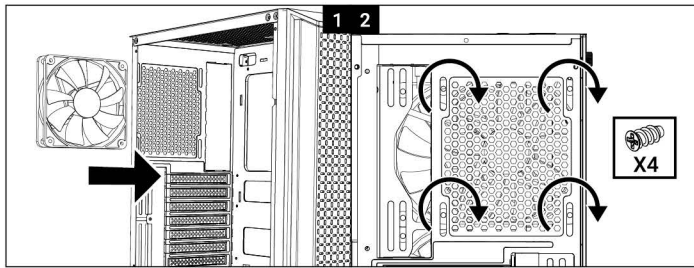

Fan (Front) Installation/Installation du ventilateur avant
風扇(前方)安裝/風扇(前方)安裝

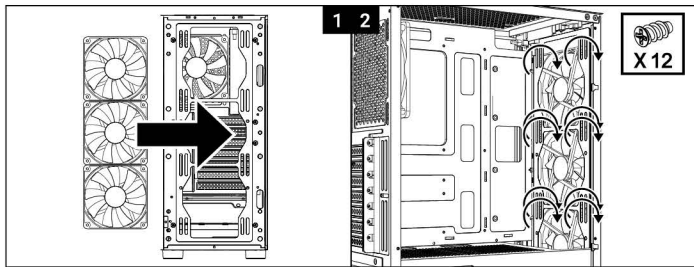



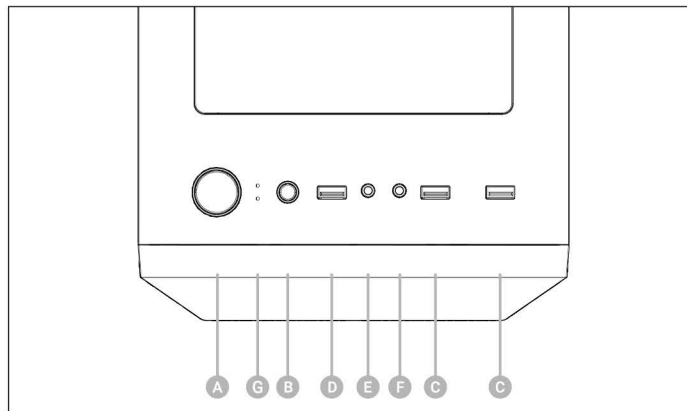
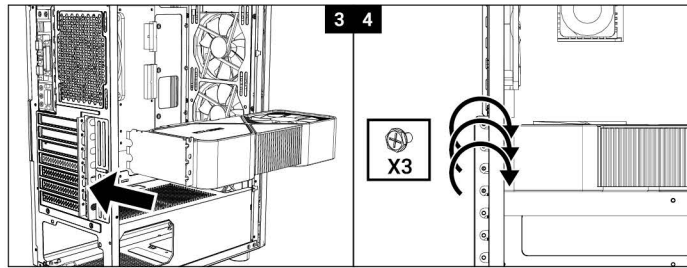
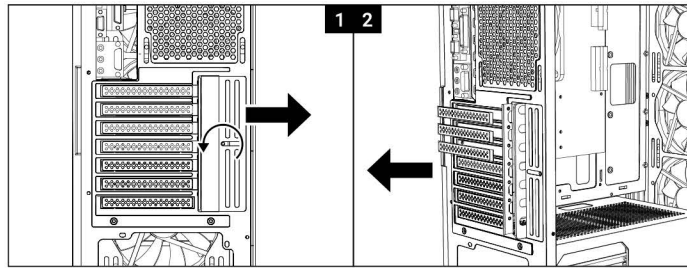
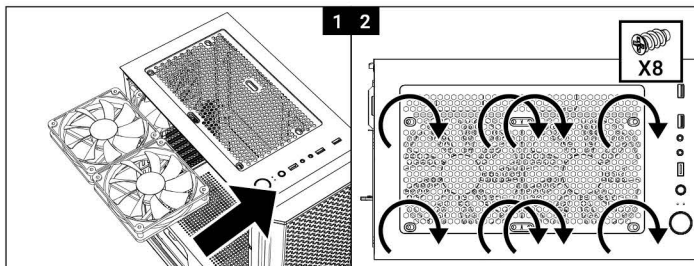







Fan (Top) Installation/Installation du ventilateur supérieur
風扇(上方)安裝/風扇(上方)安裝



- | | | |
|-----------------------|--------------------------|---------------------|
| A Power Button | D USB 3.0 Port | G LED Button |
| B Reset Button | E Headphone Jack | |
| C USB Port | F Microphone Jack | |

- | | | |
|-------------------------------------|-----------------------|-----------------------|
| A Bouton d'alimentation | A 電源開關 | A 电源开关 |
| B Bouton de réinitialisation | B 重置按鈕 | B 重置按钮 |
| C USB Port | C USB Port | C USB Port |
| D Port USB 3.0 | D USB 3.0 Port | D USB 3.0 Port |
| E Prise jack de casque | E 前置耳機孔 | E 前置耳机孔 |
| F Prise jack de microphone | F 前置麥克風孔 | F 前置麦克风孔 |
| G bouton DEL | G LED按鈕 | G LED按钮 |

 Official Website	 火鳥官方網站	 Bitfenix Webshop	
 Facebook	 Instagram	 Youtube	 Support Ticket
 火鳥臉書粉絲專頁	 火鳥官方微博	 火鳥淘寶官方店鋪	