



ARES C+P

- Quick Installation Guide
- Guide d'installation rapide
- 安裝指示說明
- 安裝指示说明

Package Content/Contenu du coffret/產品內容/产品内容

Case	Quick Installation Guide	Accessory Pack
3X Motherboard standoff	8X 3.5" HDD screw	6X PSU screw
17X Motherboard standard screw	8X Cable Tie	1X standoff nut

Boîtier	Guide d'installation rapide	Pack d'accessoires
3X entretoise de carte mère	8X vis pour disque dur 3.5"	6X vis de bloc d'alimentation
17X vis de carte mère standard	8X attache de câble	1X écrou d'écartement

機殼	安裝指示說明	配件盒
3X 主板腳柱	8X 3.5" 硬碟螺絲	6X 電源螺絲
17X 主板螺絲	8X 束線帶	1X 銅柱套

机箱	安裝指示说明	零件盒
3X 主板脚柱	8X 3.5" 硬盘螺丝	6X 电源螺丝
17X 主板螺丝	8X 扎带	1X 铜柱套

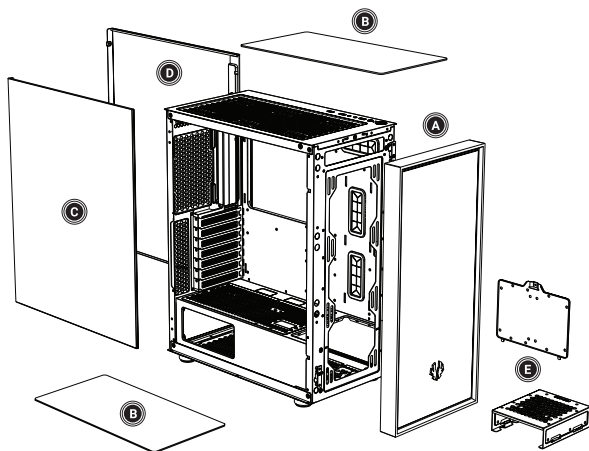

- | | | | |
|-----------------------------------|----------------------|----------|--------|
| A Front Panel | D Side Panel | A 前面板 | D 右側板 |
| B Dust Filter | E Hard Drive Tray | B 濾網 | E 硬碟支架 |
| C Tempered Glass Side Panel | | C 鋼化玻璃側板 | |
| A Panneau avant | D Panneau latéral | A 前面板 | D 右側板 |
| B Filtre anti-poussière | E Rack de disque dur | B 過濾器 | E 硬盘支架 |
| C Panneau latéral en verre trempé | | C 鋼化玻璃面板 | |

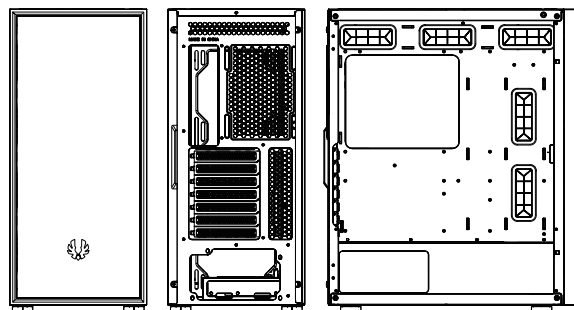

How to remove the Right side panel/Tempered glass side panel/front panel
 Comment retirer le panneau latéral droit / le panneau latéral en verre trempé / le panneau avant
 如何移除右側板 | 鋼化玻璃側板 | 前面板 | 如何移除右側板 | 鋼化玻璃側板 | 前面板

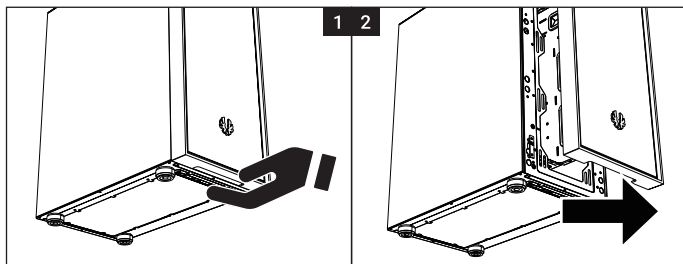
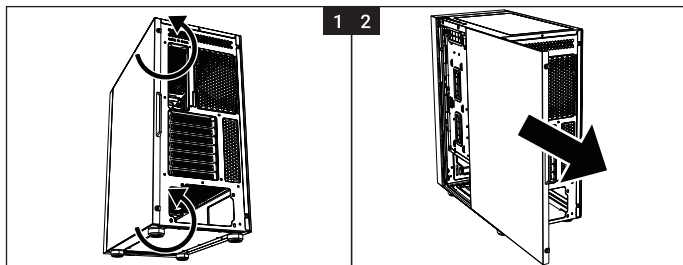
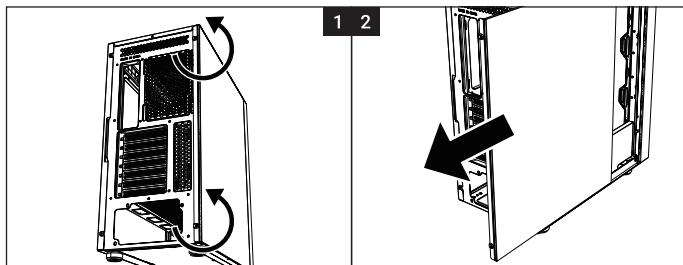

How to remove the dust filters/Comment retirer les filtres anti-poussière
 如何移除濾網 / 如何移除过滤器

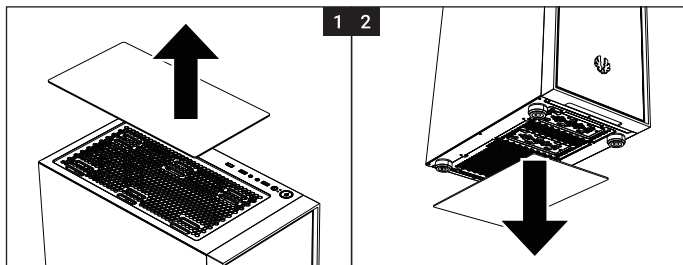

Drive Locations/Emplacements de disques dures/硬碟位置/硬盘位置

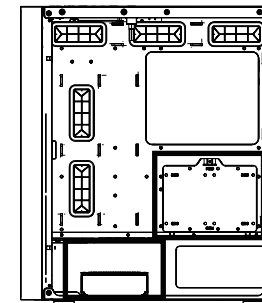

2X HDD or 1X HDD 1XSSD

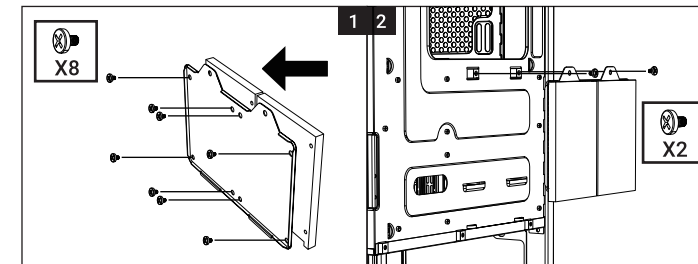
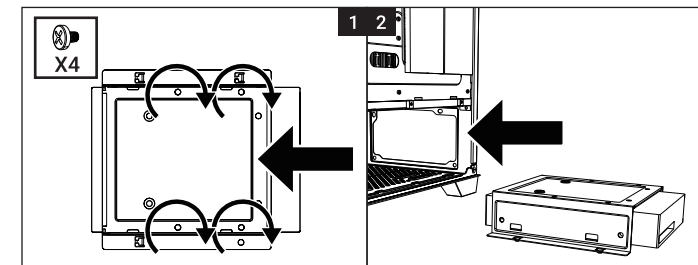
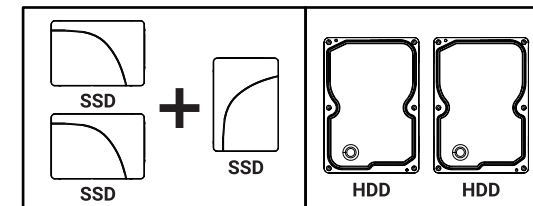

PSU Installation/Installation du bloc d'alimentation/電源安裝/电源安装

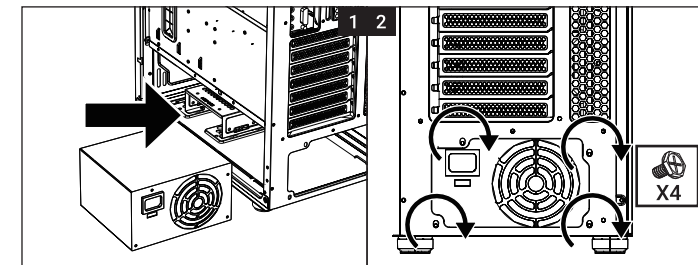

Fan (Back) Installation/Installation du ventilateur arrière
風扇(後方)安裝/風扇(後方)安裝

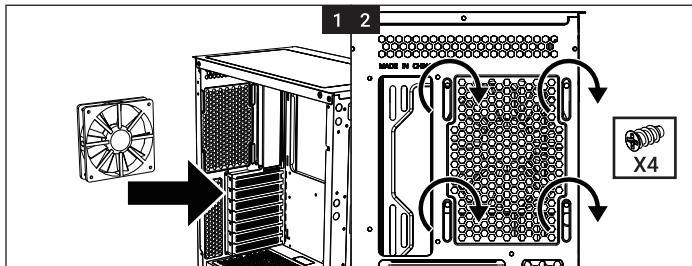

Fan (Front) Installation/Installation du ventilateur avant
風扇(前方)安裝/風扇(前方)安裝

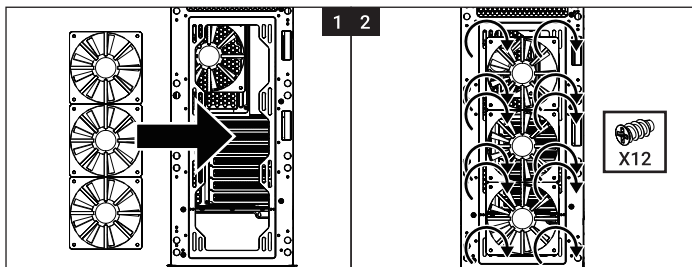

Fan (Top) Installation/Installation du ventilateur supérieur
風扇(上方)安裝/風扇(上方)安裝

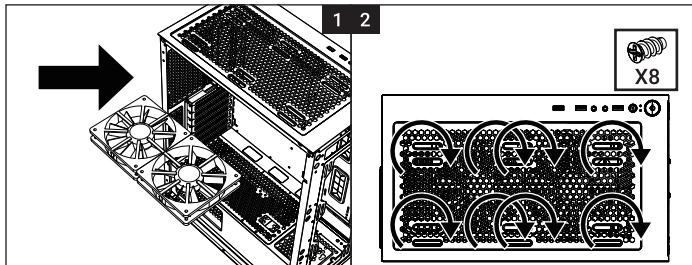

VGA Card Installation/Installation de la carte graphique/顯卡安裝/顯卡安裝

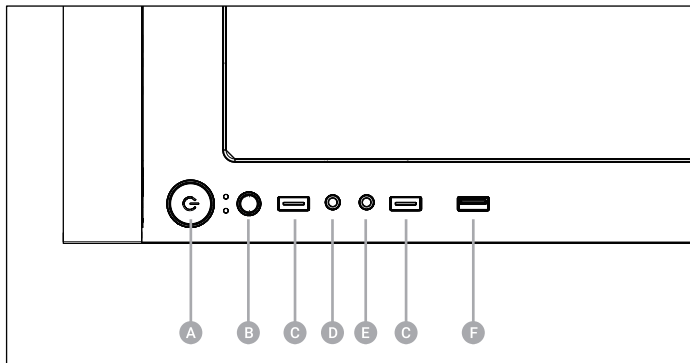
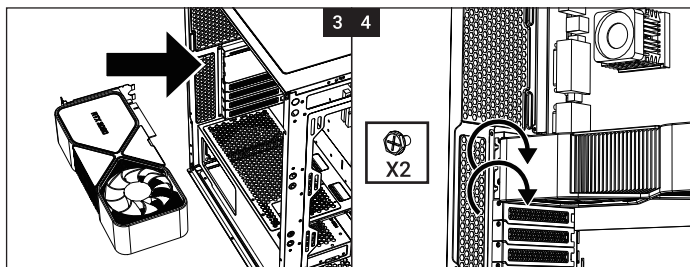
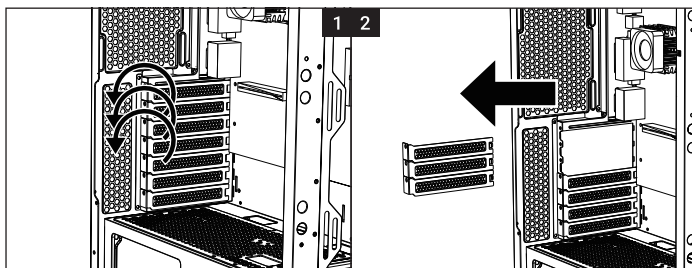

- A Power Button
- B Reset Button | LED Button
- C USB 3.0 Port
- D Headphone Jack
- E Microphone Jack
- F USB 2.0 Port

- | | | |
|---|----------------|----------------|
| A Bouton d'alimentation | A 電源開關 | A 电源开关 |
| B Bouton de réinitialisation bouton DEL | B 重置按鈕 LED按鈕 | B 重置按钮 LED按钮 |
| C Port USB 3.0 | C USB 3.0 Port | C USB 3.0 Port |
| D Prise jack de casque | D 前置耳機孔 | D 前置耳机孔 |
| E Prise jack de microphone | E 前置麥克風孔 | E 前置麦克风孔 |
| F USB 2.0 Port | F USB 2.0 Port | F USB 2.0 Port |



Official Website



火鳥官方網站



Bitfenix Webshop



Facebook



Instagram



Youtube



Support Ticket



火鳥臉書粉絲專頁



火鳥官方微博



火鳥淘寶官方店鋪